



Trax

Innovative extrusion profile solutions matched with variety of light source to deliver unique lighting solutions in a space which includes cove lighting, furniture lighting, floor wash and even handrails



Project - Hotel ITC Narmada
Ahmedabad, India

Trax - Features

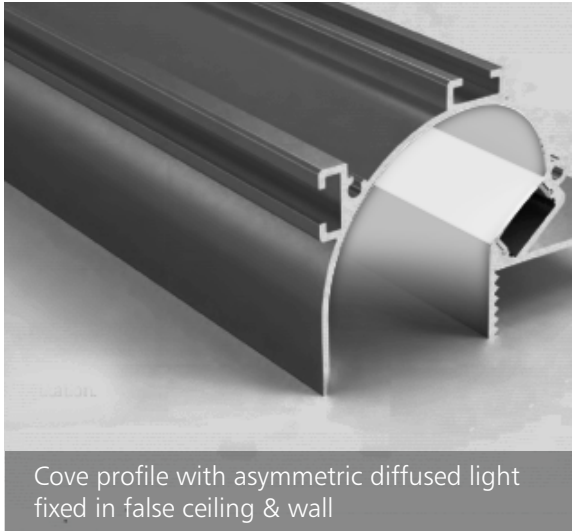

Cove profile with asymmetric diffused light fixed in false ceiling & wall

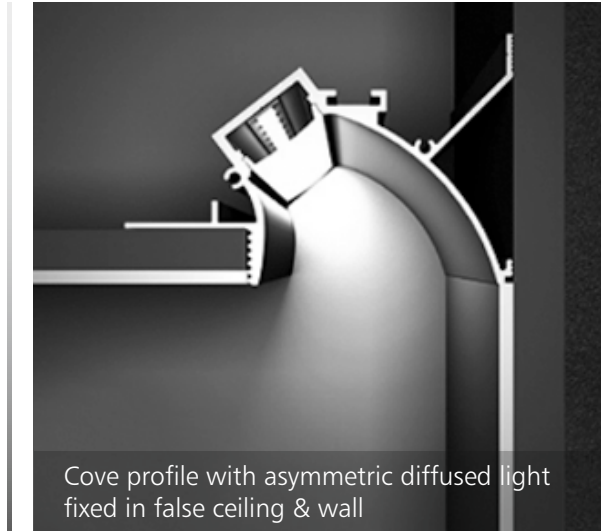

Cove profile with asymmetric diffused light fixed in false ceiling & wall

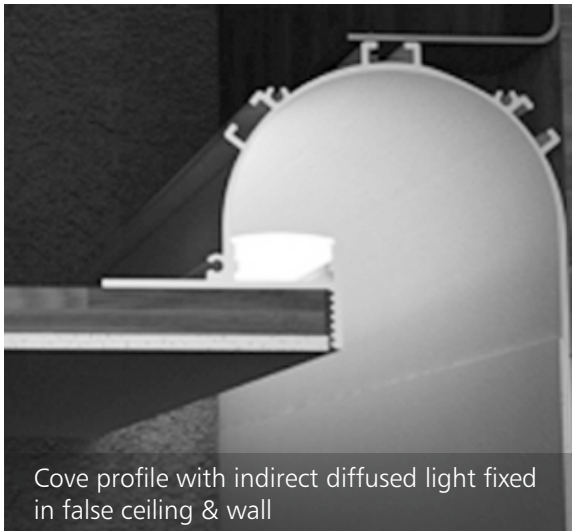

Cove profile with indirect diffused light fixed in false ceiling & wall

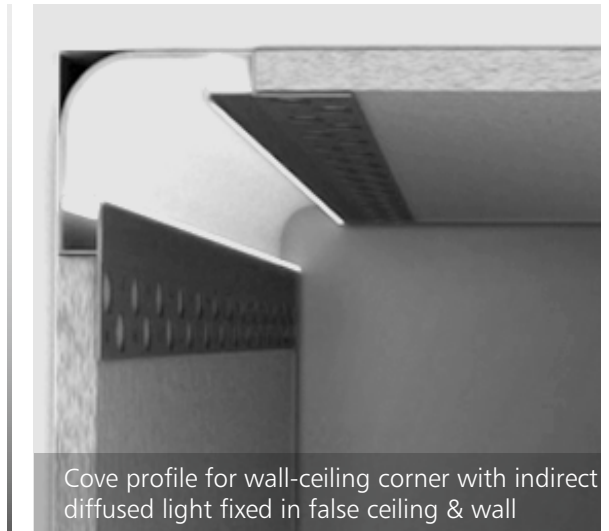

Cove profile for wall-ceiling corner with indirect diffused light fixed in false ceiling & wall

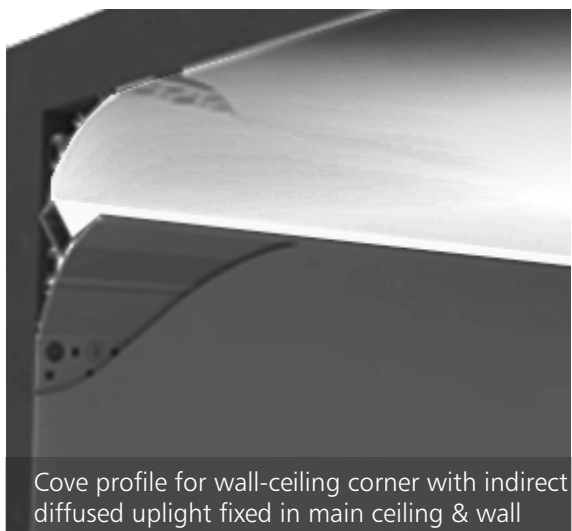

Cove profile for wall-ceiling corner with indirect diffused upright fixed in main ceiling & wall

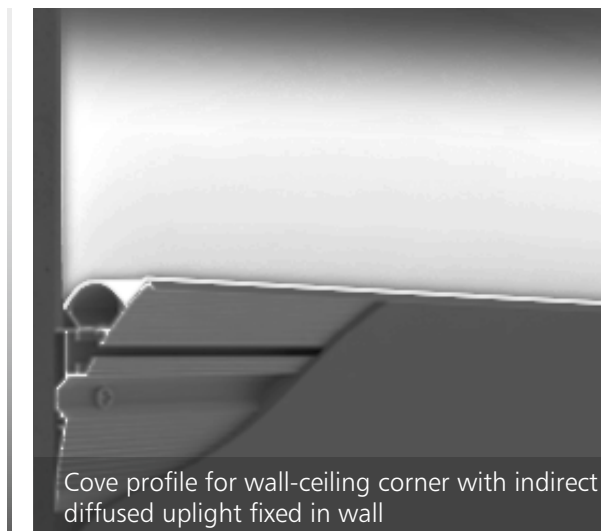

Cove profile for wall-ceiling corner with indirect diffused upright fixed in wall

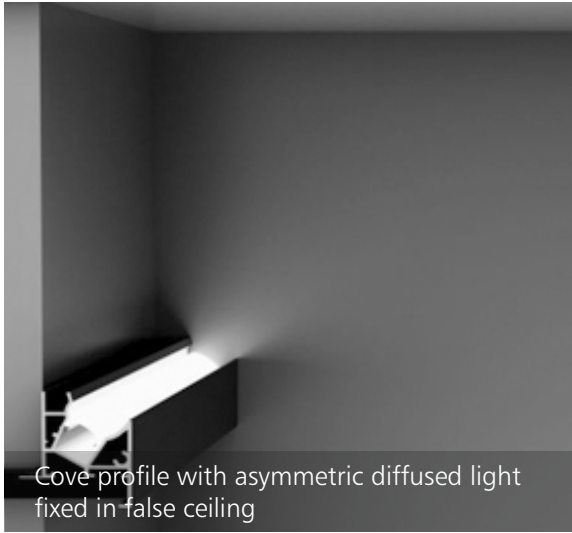

Cove profile with asymmetric diffused light fixed in false ceiling



Cove profile with indirect diffused light fixed in false ceiling



Skirting profile with indirect diffused light fixed in wall at floor level

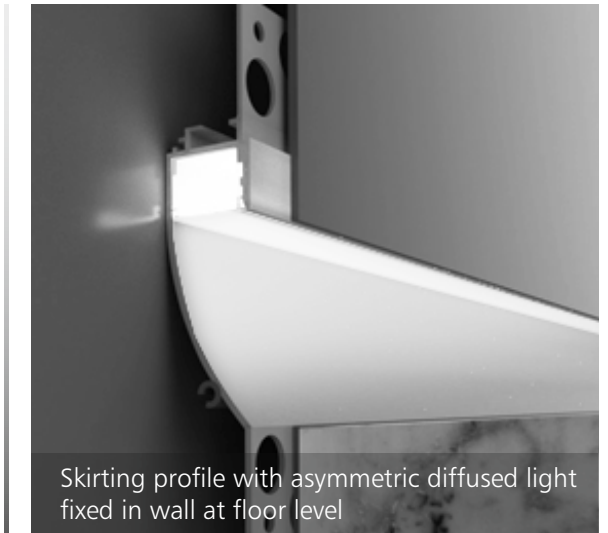

Skirting profile with asymmetric diffused light fixed in wall at floor level

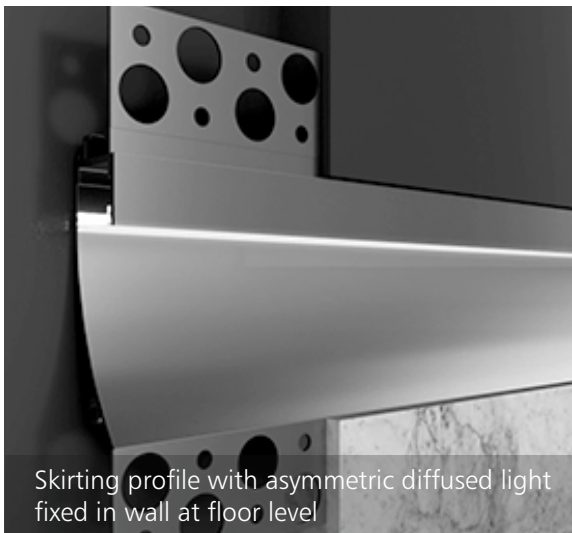

Skirting profile with asymmetric diffused light fixed in wall at floor level



Skirting profile with indirect diffused light fixed in wall at floor level

Trax - Features

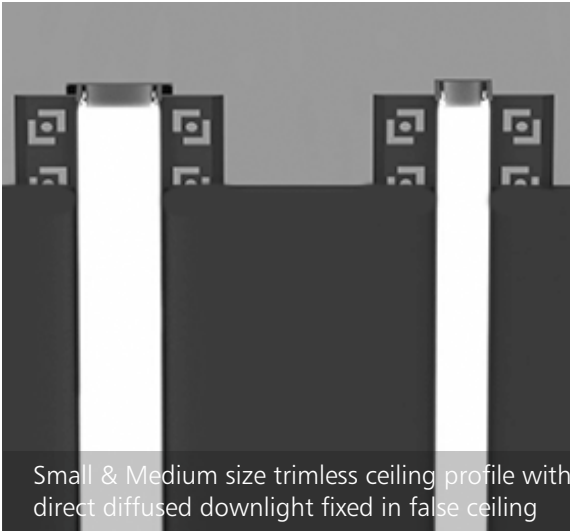

Small & Medium size trimless ceiling profile with direct diffused downlight fixed in false ceiling

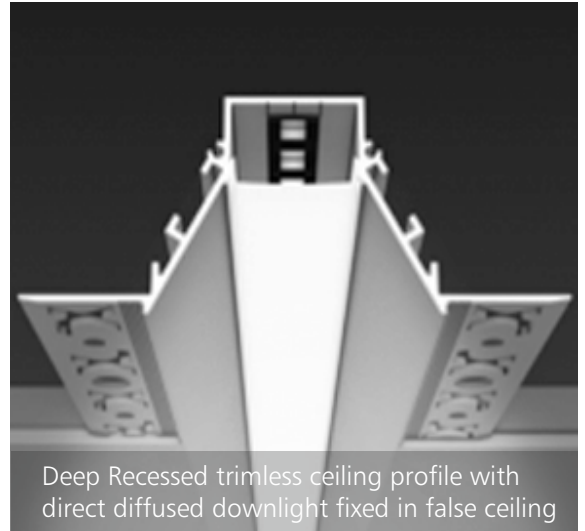

Deep Recessed trimless ceiling profile with direct diffused downlight fixed in false ceiling

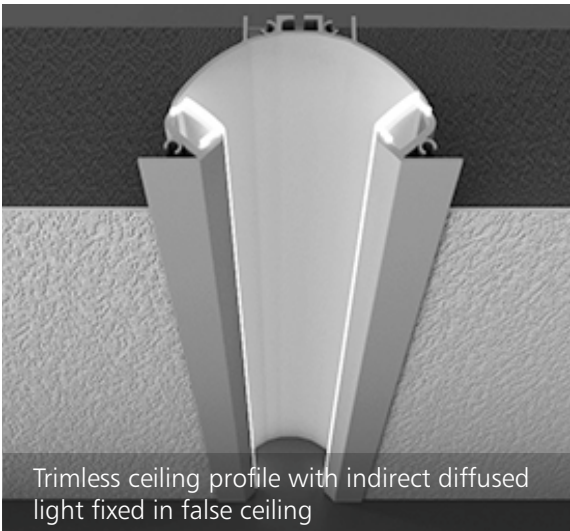

Trimless ceiling profile with indirect diffused light fixed in false ceiling

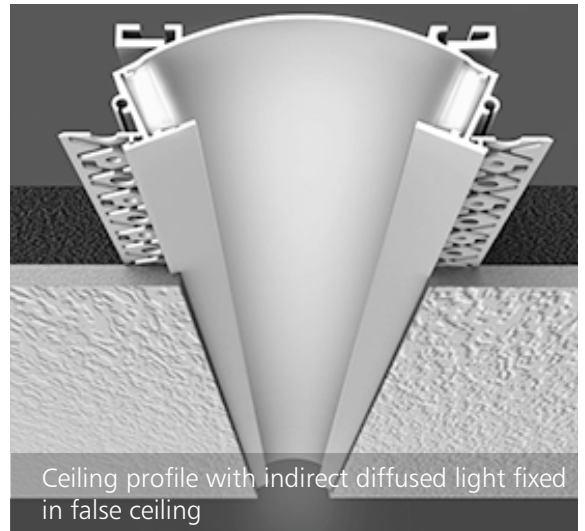

Ceiling profile with indirect diffused light fixed in false ceiling

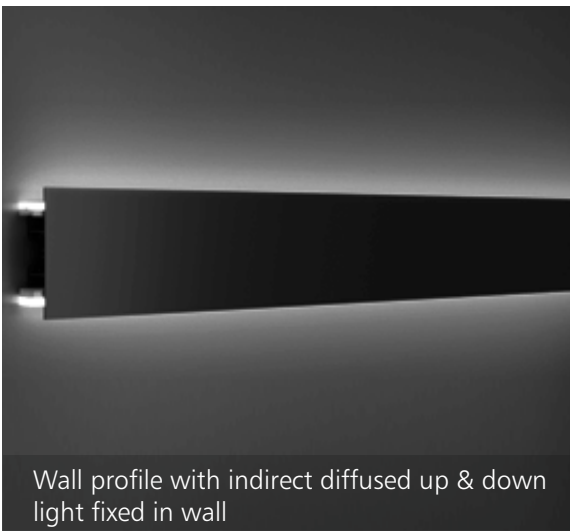

Wall profile with indirect diffused up & down light fixed in wall



Wall profile with indirect diffused uplight fixed in wall



Furniture profile recessed with asymmetric diffused light

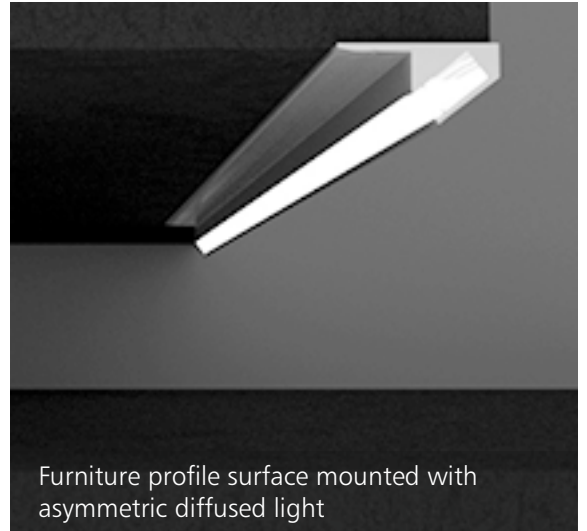

Furniture profile surface mounted with asymmetric diffused light

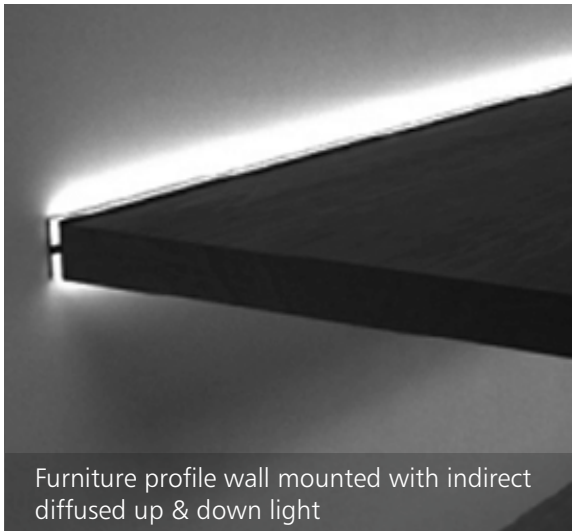

Furniture profile wall mounted with indirect diffused up & down light



Furniture profile wardrobe mounted with indirect diffused light

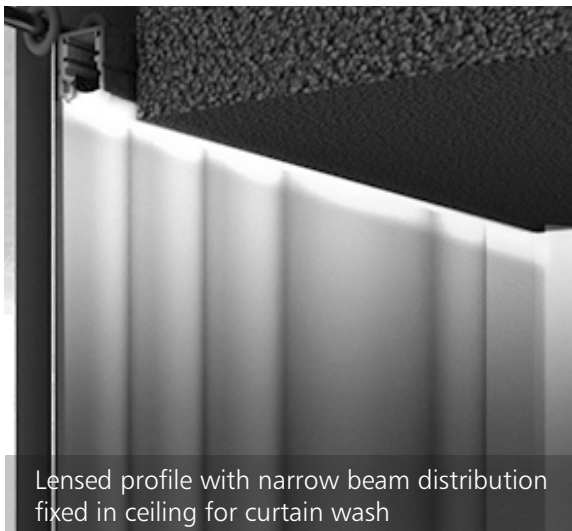

Lensed profile with narrow beam distribution fixed in ceiling for curtain wash

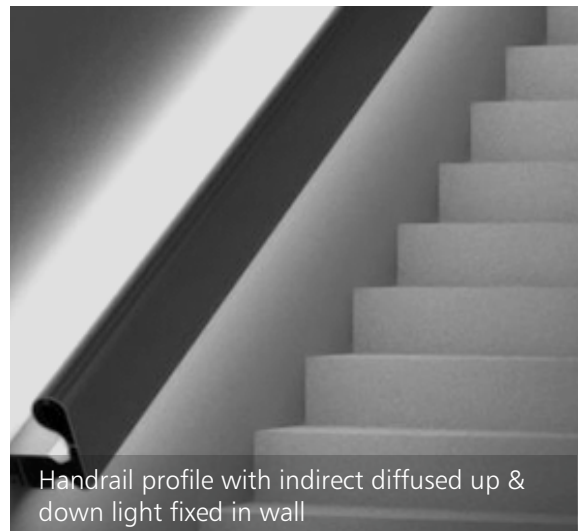

Handrail profile with indirect diffused up & down light fixed in wall

Trax

LED	Typ CRI	Body Finish	Max Length	IP Rating	Filter Options
Low Power 3 Step MacAdam L90-B10 60,000Hrs	92	Matt White	3000MM	IP20	NA



Cove Asymmetric M
#2073

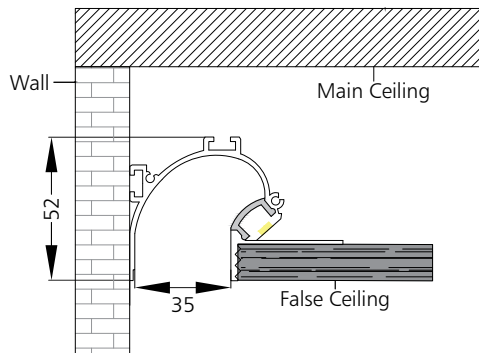

LED strips options*

Svelte 6 #2010	Svelte 12 #2013
Svelte 24 #2016	Tunable #2029

*Refer to Svelte series for technical data

Trimless Mounting

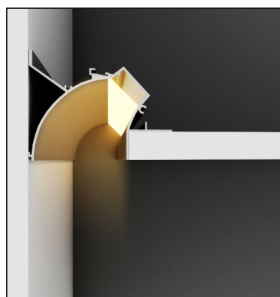

Cove Asymmetric L
#2071

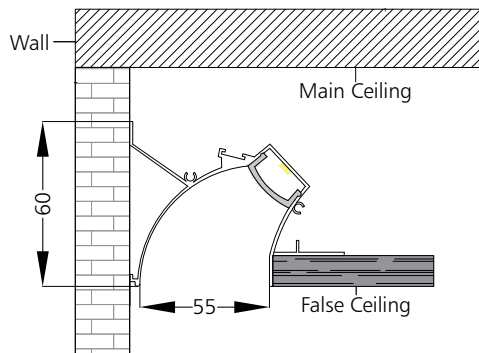

LED strips options*

Svelte 6 #2010	Svelte 12 #2013
Svelte 24 #2016	Tunable #2029

*Refer to Svelte series for technical data

Trimless Mounting

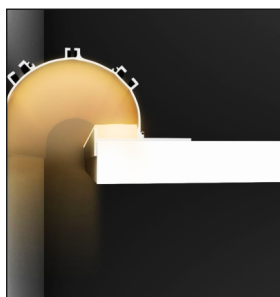

Cove Diffused
#2072

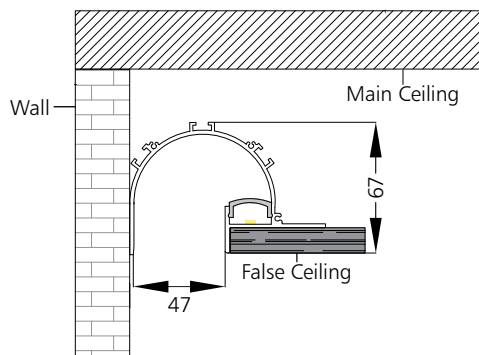

LED strips options*

Svelte 6 #2010	Svelte 12 #2013
Svelte 24 #2016	Tunable #2029

*Refer to Svelte series for technical data

Trimless Mounting

Trax

LED	Typ CRI	Body Finish	Max Length	IP Rating	Filter Options
Low Power 3 Step MacAdam L90-B10 60,000Hrs	92	Matt White	3000MM	IP20	NA

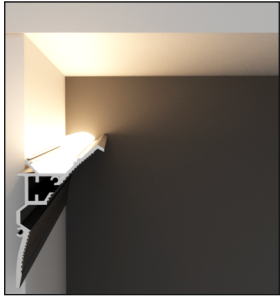

Cove Uplight M
#2075

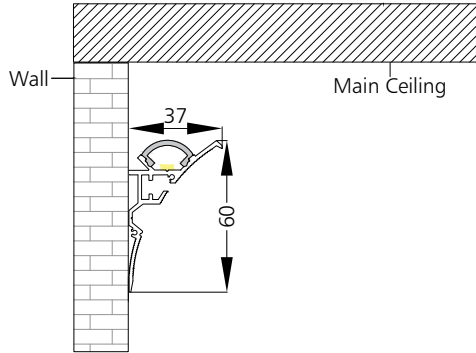

LED strips options*

Svelte 6 #2010	Svelte 12 #2013
Svelte 24 #2016	Tunable #2029

*Refer to Svelte series for technical data

Trimless Mounting

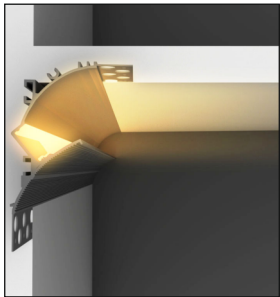

Cove Uplight L
#2076

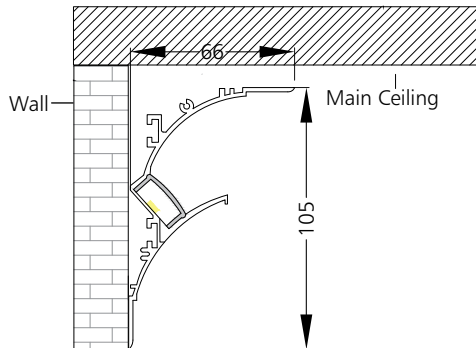

LED strips options*

Svelte 6 #2010	Svelte 12 #2013
Svelte 24 #2016	Tunable #2029

*Refer to Svelte series for technical data

Trimless Mounting

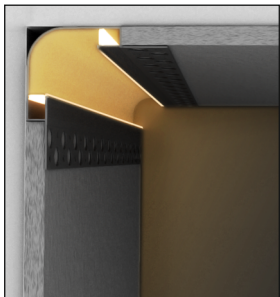

Cove Curved Corner
#2077

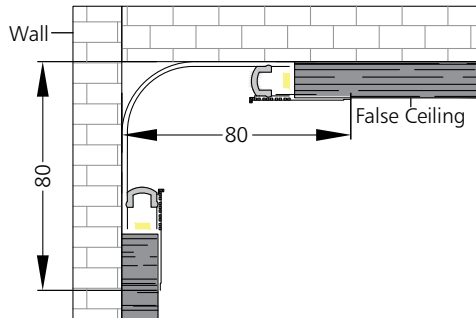

LED strips options*

Svelte 6 #2010	Svelte 12 #2013
Svelte 24 #2016	Tunable #2029

*Refer to Svelte series for technical data

Trimless Mounting

Trax

LED	Typ CRI	Body Finish	Max Length	IP Rating	Filter Options
Low Power 3 Step MacAdam L90-B10 60,000Hrs	92	Anodized	3000MM	IP20	NA

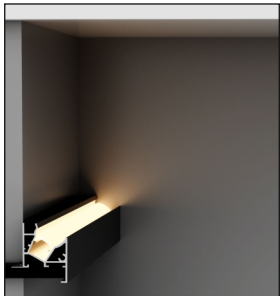

Cove Edge Angular
#2063

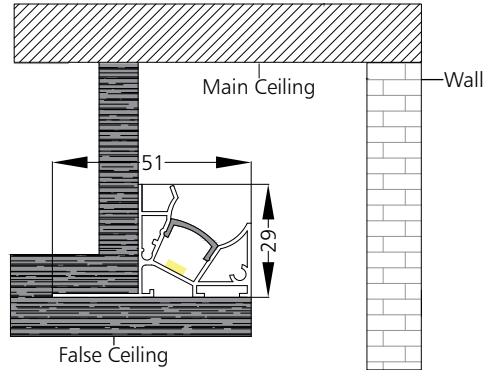

LED strips options*

Svelte 6
#2010

Svelte 12
#2013

Svelte 24
#2016

Tunable
#2029

*Refer to Svelte series for technical data



Cove Edge Flat
#2064

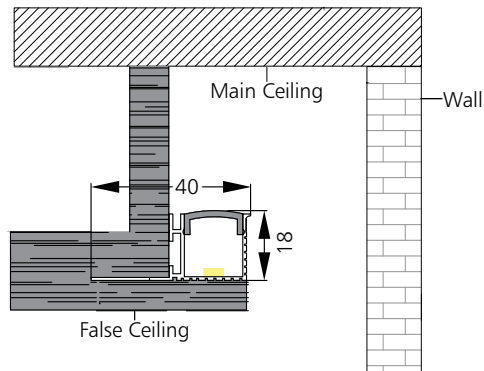

LED strips options*

Svelte 6
#2010

Svelte 12
#2013

Svelte 24
#2016

Tunable
#2029

*Refer to Svelte series for technical data

Trimless Mounting



Floor Flat
#2081

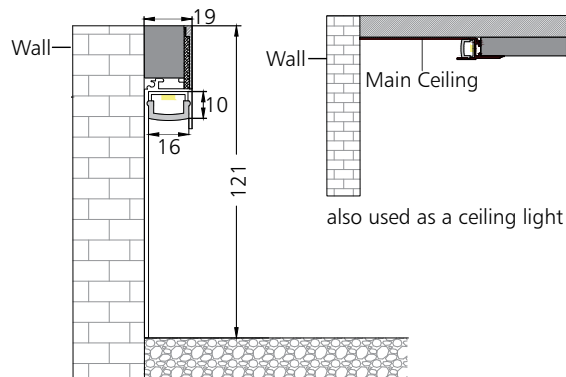

LED strips options*

Svelte 6
#2010

Svelte 12
#2013

Svelte 24
#2016

Tunable
#2029

*Refer to Svelte series for technical data

Trax

LED	Typ CRI	Body Finish	Max Length	IP Rating	Filter Options
Low Power 3 Step MacAdam L90-B10 60,000Hrs	92	Matt White	3000MM	IP20	NA

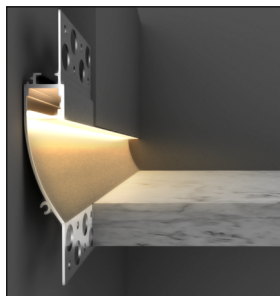

Floor Curve S
#2078

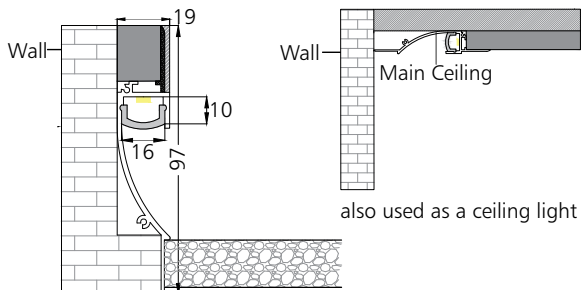

LED strips options*

Svelte 6 #2010	Svelte 12 #2013
Svelte 24 #2016	Tunable #2029

*Refer to Svelte series for technical data



Floor Curve M
#2079

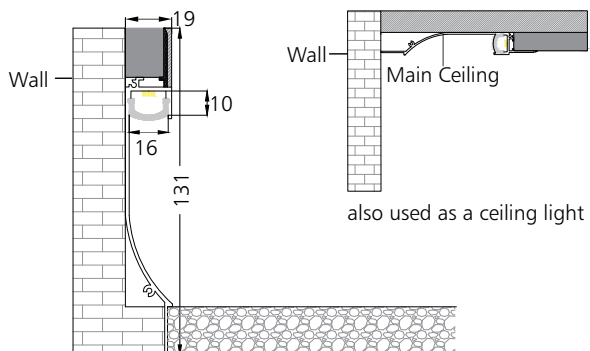

LED strips options*

Svelte 6 #2010	Svelte 12 #2013
Svelte 24 #2016	Tunable #2029

*Refer to Svelte series for technical data

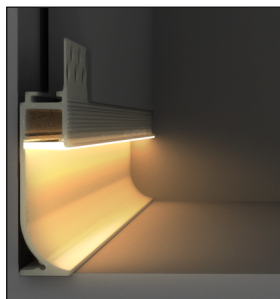

Floor Surface
#2080

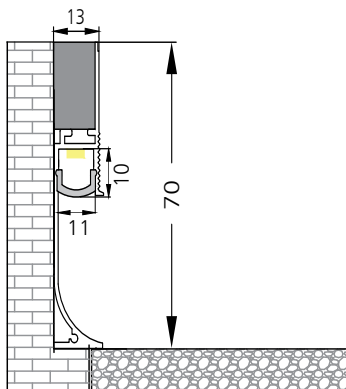

LED strips options*

Svelte 6 #2010	Svelte 12 #2013
Svelte 24 #2016	Tunable #2029

*Refer to Svelte series for technical data

Trax

LED	Typ CRI	Body Finish	Max Length	IP Rating	Filter Options
Low Power 3 Step MacAdam L90-B10 60,000Hrs	92	Matt White	3000MM	IP20	NA

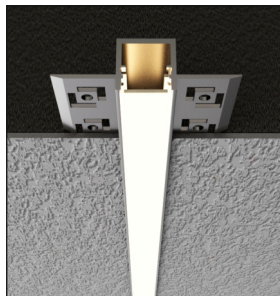

Ceiling S
#2068

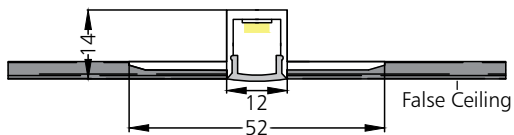

LED strips options*

Svelte 6
#2010

Svelte 12
#2013

Tunable
#2029

*Refer to Svelte series for technical data

Trimless Mounting



Ceiling M
#2069

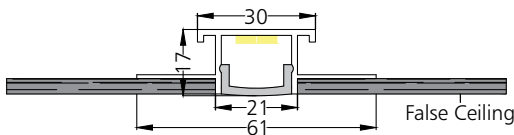

LED strips options*

Svelte 24 L
#2003

*Refer to Svelte series for technical data

Trimless Mounting

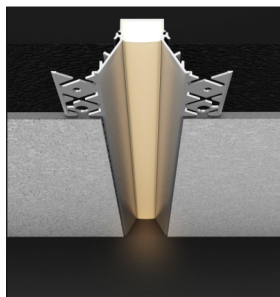

Ceiling Deep
#2070

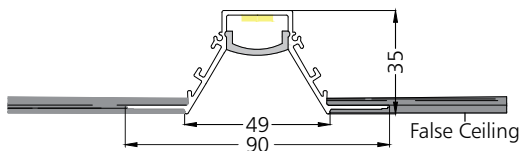

LED strips options*

Svelte 24 L
#2003

*Refer to Svelte series for technical data

Trimless Mounting

Trax

LED	Typ CRI	Body Finish	Max Length	IP Rating	Filter Options
Low Power 3 Step MacAdam L90-B10 60,000Hrs	92	Matt White	3000MM	IP20	NA



Ceiling Indirect
#2066

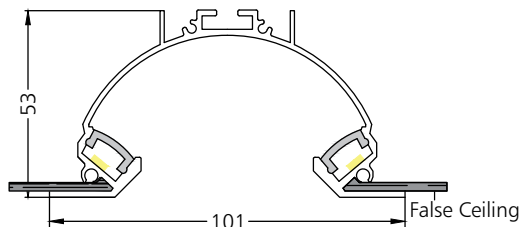

LED strips options*

Svelte 6 #2010	Svelte 12 #2013
Svelte 24 #2016	Tunable #2029

*Refer to Svelte series for technical data

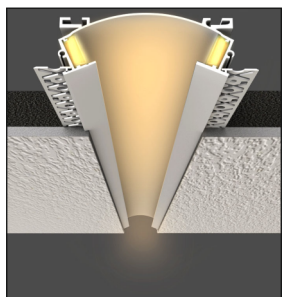

Ceiling Indirect TL
#2067

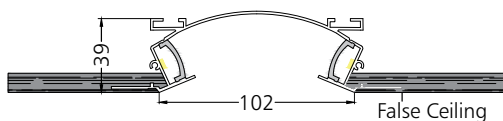

LED strips options*

Svelte 6 #2010	Svelte 12 #2013
Svelte 24 #2016	Tunable #2029

*Refer to Svelte series for technical data

Trimless Mounting

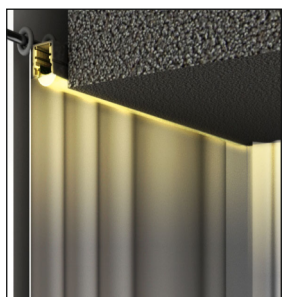

Wash Lens
#2062

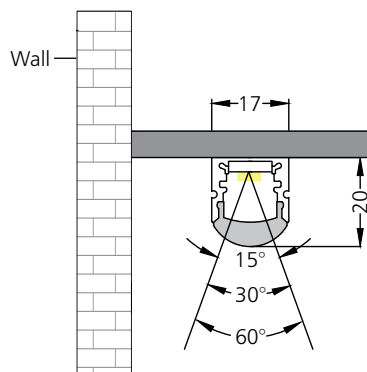

LED strips options*

Svelte 6 #2010	Svelte 12 #2013
Svelte 24 #2016	Tunable #2029

*Refer to Svelte series for technical data

Trax

LED	Typ CRI	Body Finish	Max Length	IP Rating	Filter Options
Low Power 3 Step MacAdam L90-B10 60,000Hrs	92	Matt White Matt Black	3000MM	IP20	NA

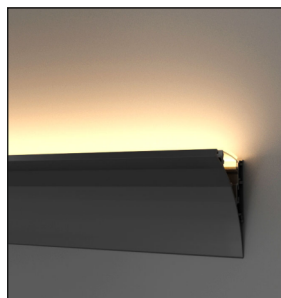

Wall
#2088

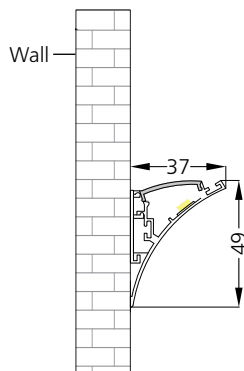

LED strips options*

Svelte 6
#2010

Svelte 12
#2013

Svelte 24
#2016

Tunable
#2029

*Refer to Svelte series for technical data



Wall Up-Down
#2089

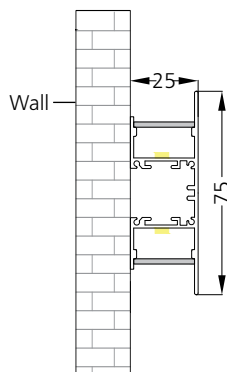

LED strips options*

Svelte 6
#2010

Svelte 12
#2013

Svelte 24
#2016

Tunable
#2029

*Refer to Svelte series for technical data



Railing
#2090

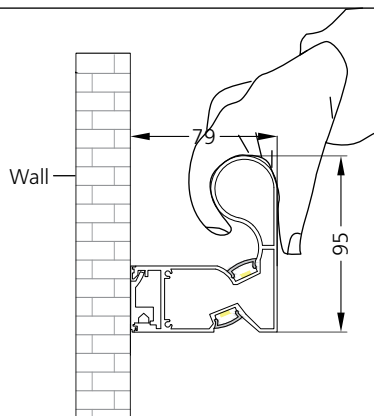

LED strips options*

Svelte 6
#2010

Svelte 12
#2013

Svelte 24
#2016

Tunable
#2029

*Refer to Svelte series for technical data

Trax

LED	Typ CRI	Body Finish	Max Length	IP Rating	Filter Options
Low Power 3 Step MacAdam L90-B10 60,000Hrs	92	Matt Black	3000MM	IP20	NA

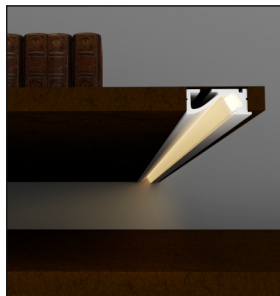

Shelf Recessed
#2085



LED strips options*

Svelte 6 Mini
#2001

Svelte 12 Mini
#2002

*Refer to Svelte series for technical data

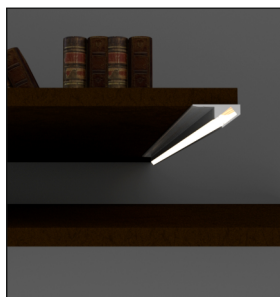

Shelf Surface
#2086

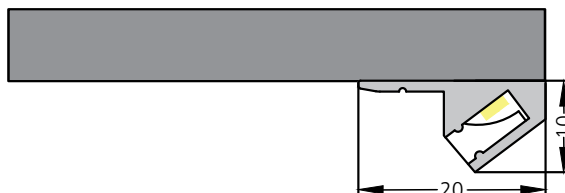

LED strips options*

Svelte 6 Mini
#2001

Svelte 12 Mini
#2002

*Refer to Svelte series for technical data

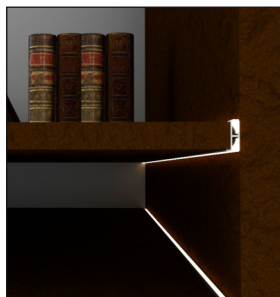

Shelf Corner
#2087

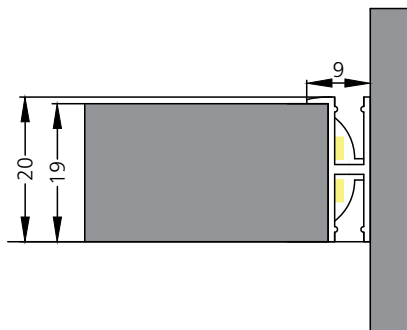

LED strips options*

Svelte 6 Mini
#2001

Svelte 12 Mini
#2002

*Refer to Svelte series for technical data

Trax

LED	Typ CRI	Body Finish	Max Length	IP Rating	Filter Options
Low Power 3 Step MacAdam L90-B10 60,000Hrs	92	Matt White Matt Black	3000MM	IP20	NA



Hanger
#2065

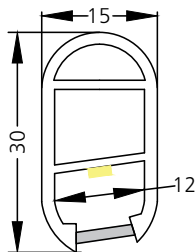

LED strips options*

Svelte 6
#2010

Svelte 12
#2013

*Refer to Svelte series for technical data

